

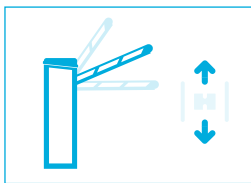

"A barrier gate for general use"

Smart Barrier Gate JSDZ 0208



Rapid Opening

- Raising a four-meter boom pole in between **0.8 seconds and 2 seconds** and lowering it just as quickly

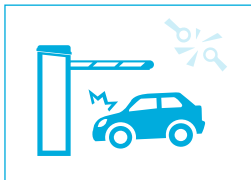

Robust

- **High-strength carbon steel splicing frame**--overall structure is solid and reliable
- **Brand-new spraying process**--uniform color, high saturation, high hardness layer for improving corrosion resistance and weather resistance
- **Integrated movement design**-- gate runs stably and core components are resistant to wear

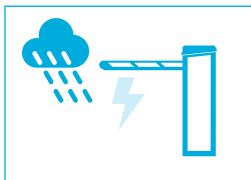

Safe & Reliable

- **Boom auto rebound protection**--detect obstruction and boom rebound
- **Operation jam protection**--the control system can automatically reduce the voltage and current to prevent the motor from being burned out.
- **Comprehensive anti-crushing protections**: infrared anti crushing, radar anti crushing, digital anti crushing, loop detector for anti crushing
- Adopt **digital control technology** -- protect gate operation in whole process, such as boom limit position protection, ambient temperature compensation protection, anti-blocking protection, illegal lifting alarm and record, etc.

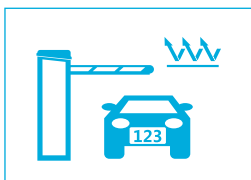

Four Opening Methods

- Gate boom opened by **loop detector**
- Gate boom opened by PMS ("Parking Management System") **software**
- Gate boom opened by **remote control**
- Gate boom opened by **motor** (There is a knob on motor and only be used in emergency)

Specifications

Model Name	JSDZ0208
Power Supply	AC220±10% AC110±10%
Operating Temperature	-25℃ ~70℃
Relative Humidity	≤95%
Motor Power	150W
Communication Interface	IO, TCP/IP
MCBF	3 mio cycles
IP Rating	IP54
Anti crushing	digital anti crushing, loop detector for anti crushing, infrared anti crushing (optional), radar anti crushing (optional)
Height of Boom	930mm
Dimension (L*W*H)	365×322×1049mm



Straight Boom

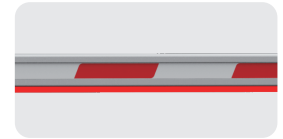

Luminous Boom

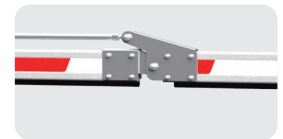

Folding Boom

Barrier Booms

Boom Type	Model name	Boom Length	Speed	Anti-collision	Boom Material	Anti-smashing Strip	Reflective Membrane
Straight Boom	JSDZ0208	4m	0.8-2.0s	/	Aluminum alloy	Optional	Red+White
Luminous Boom		3.5m	0.8-2.0s	/	Aluminum alloy	Optional	Red+White
Folding Boom	JSDZ0208B-03	3.5m	1.5-2.0s	/	Aluminum alloy	Optional	Red+White
		3m	1.5-2.0s	/	Aluminum alloy	Optional	Red+White

Dimensions

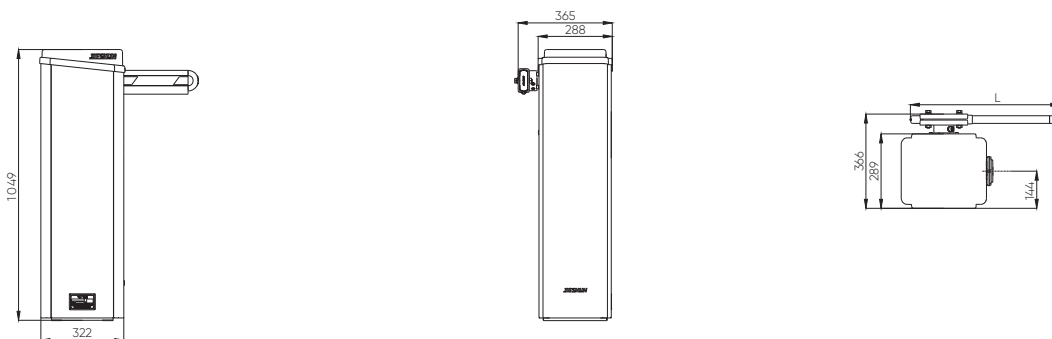

*Design and specification are subject to change without prior notice. All information was correct at the time of print. All company names, product names and logotypes are trademarks or registered trademarks of their respective owners. ©Shenzhen Jieshun Science and Technology Industry Co., Ltd. September 2019. All trademarks acknowledged.